

HC Series – Bare Tube Bundle Shell & Tube Water to Oil Cooling

The HC Series shell & tube style offers the widest variety of options for utilizing multiple cooling water requirements for oil or compressed air cooling. It remains the industry standard in ultimate value and long-term reliability. The proven fixed tubesheet design shell and tube heat exchanger offers the cost effectiveness that comes with having a highly standard design, while easily providing for various options to meet specific application requirements. Multiple material options are available as well.

TTP's XSelector sizing program can help dial in sizing to optimize water usage.

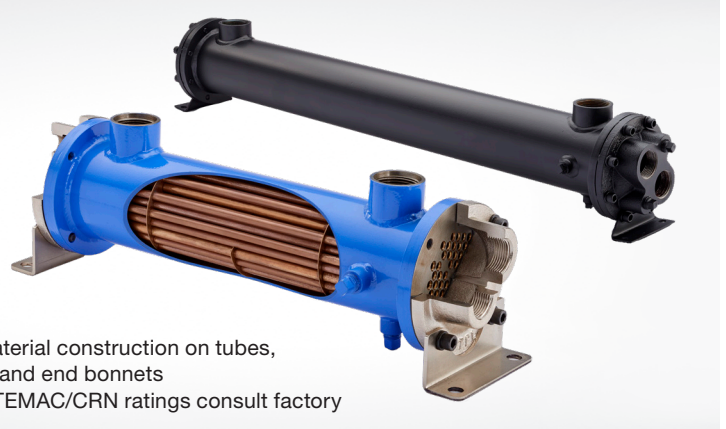

OPTIONS

Optional material construction on tubes, tubesheets and end bonnets
For ASME/TEMAC/CRN ratings consult factory

How to Order

Model Series

HC = NPT Shell Side Connectons x NPT Tube Side Connections
HCS = SAE ORB Shell Side Connectons x NPT Tube Side Connections
HCM = BSPP Shell Side Connectons x BSPP Tube Side Connections
HCF = SAE Code 61 Flanges on Shell Side (UNC Threads) x NPT Tube Side Connections
HCFM = SAE Code 61 Flanges on Shell Side (Metric Threads) x NPT Tube Side Connections
+HCA = 150# ASME RF Flanges on Shell Side x NPT Tube Side Connections.
(+Shell Maximum Pressure Rating is 150 psi)

Model Size Selected

614, 624, 814, 824, 836, 1014, 1024, 1036, 1224, 1236, 1248, 1260, 1724, 1736, 1748, 1760, 1772
(See Performance Curve Chart on page 3 for sizes or **XSelector*** sizing program)

Baffle Spacing

1.3, 1.7, 2, 2.5, 3, 3.5, 4, 5, 6, 8.4
(Baffle spacing is dependent on applicable sizes found in sizing charts on page 3 or can be determined by using **XSelector*** sizing program)

Tube Diameter Code

4 - 1/4" (600 & 800 Series)
6 - 3/8" (1000, 1200 & 1700 Series)

Tubeside Passes

0 - One Pass
T - Two Pass
F - Four Pass

Cooling Tube Material

Blank - Copper
CN - Copper Nickel
SS - Stainless Steel
AD - Admiralty Brass

End Bonnet Material

Blank - Cast Iron
B - Bronze
SB - Stainless Steel

Tubesheet Material

Blank - Carbon Steel
W - Copper Nickel
S - Stainless Steel

Zinc Anodes

Blank - None
Z - Zinc

Features

Interchangeable with TTP C Series

Cooling Tube Material Options

- Standard Steel
- Bronze
- Copper Nickel
- Admiralty Brass
- Stainless Steel

Multiple Connection Options

- NPT x NPT
- BSPP x BSPP
- SAE x NPT
- 150# ASME RF Flanges x NPT
- SAE Code 61 x NPT

End Bonnets Removable for Servicing

Mounting Feet Included (May be rotated in 90° increments)

Materials

Tubes Copper/Copper Nickel/Stainless Steel/Admiralty Brass

Tubesheet Carbon Steel/Copper Nickel/Stainless Steel

Shell Carbon Steel

Baffles Carbon Steel

End Bonnets Cast Iron/Bronze/Stainless Steel

Mounting Brackets Carbon Steel

Gaskets Nitrile Rubber/Cellulose Fiber

Nameplate Aluminum Foil

Ratings

Maximum Operating Pressure - Shell Side
300 PSI

Maximum Operating Pressure - Tube Side
150 PSI

Maximum Operating Temperature
300°F

Selection Procedure

Performance Curves are based on 100SSU oil leaving the cooler 40°F higher than the incoming water temperature (40°F approach temperature). Curves are based on a 2:1 oil to water ratio.

STEP 1 Determine the Heat Load. This will vary with different systems, but typically coolers are sized to remove 25 to 50% of the input nameplate horsepower. (Example: 100 HP Power Unit x .33 = 33 HP Heat load.)
If BTU/HR is known: $HP = \frac{BTU/HR}{2545}$

STEP 2 Determine Approach Temperature.
Desired oil leaving cooler °F – Water Inlet temp. °F = Actual Approach

STEP 3 Determine Curve Horsepower Heat Load. Enter the information from above:
 $HP \text{ heat load} \times \frac{40}{\text{Actual Approach}} \times \text{Viscosity Correction A} = \text{Curve Horsepower}$

STEP 4 Enter curves at oil flow through cooler and curve horsepower. Any curve above the intersecting point will work.

STEP 5 Determine Oil Pressure Drop from Curves. Multiply pressure drop from curve by correction factor B found on oil viscosity correction curve.
I = 5 PSI n = 10 PSI = 20 PSI

Oil Temperature

Oil coolers can be selected by using entering or leaving oil temperatures.

Typical operating temperature ranges are:

Hydraulic Motor Oil	110°F - 130°F
Hydrostatic Drive Oil	130°F - 180°F
Lube Oil Circuits	110°F - 130°F
Automatic Transmission Fluid	200°F - 300°F

Desired Reservoir Temperature

Return Line Cooling: Desired temperature is the oil temperature leaving the cooler. This will be the same temperature that will be found in the reservoir.

Off-Line Recirculation Cooling Loop: Desired temperature is the temperature entering the cooler. In this case, the oil temperature change must be determined so that the actual oil leaving temperature can be found. Calculate the oil temperature change (Oil ΔT) with this formula:

$$\text{Oil } \Delta T = (\text{BTUs/HR}) / (\text{GPM Oil Flow} \times 210)$$

To calculate the oil leaving temperature from the cooler, use this formula:

$$\text{Oil Leaving Temperature} = \text{Oil Entering Temperature} - \text{Oil } \Delta T$$

This formula may also be used in any application where the only temperature available is the entering oil temperature.

Oil Pressure Drop: Most systems can tolerate a pressure drop through the heat exchanger of 20 to 30 PSI. Excessive pressure drop should be avoided. Care should be taken to limit pressure drop to 5 PSI or less for case drain applications where high back pressure may damage the pump shaft seals.

Viscosity Correction

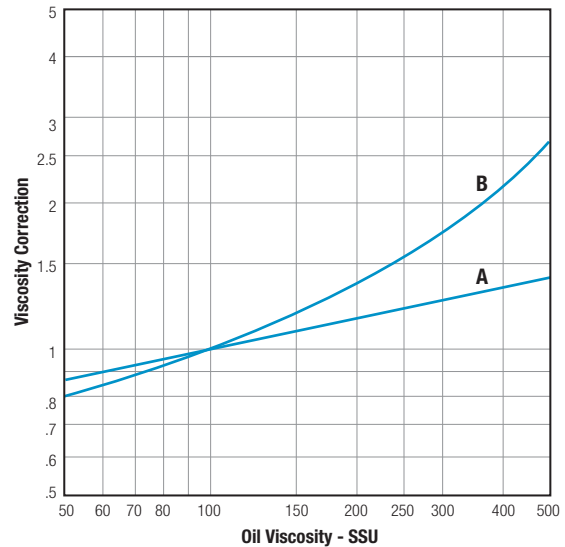

Maximum Flow Rates

Example Model No.

HC - 1024 - 2 - 6 - F

Unit Size	Baffle Spacing	Shell Side (GPM)	Tube Side (GPM)		
			O	T	F
600	1.3, 3	19, 29	48	24	12
800	1.7, 4	32, 69	84	42	21
1000	2, 5	41, 69	146	73	37
1200	2.5, 6	60, 115	224	112	56
1700	3.5, 8.4	125, 253	465	232	116

Exceptions to Maximum Shell Side Flows

HC-814-4-4-*	63 GPM Max.
HC-1014-2-6-*	33 GPM Max.
HC-1014-5-6-*	66 GPM Max.
HC-1724-3.5-6-*	105 GPM Max.
HC-1724-8.4-6-*	200 GPM Max.

Caution: Incorrect installation can cause this product to fail prematurely, causing the shell side and tube side fluids to intermix.

Piping Diagram

One Pass

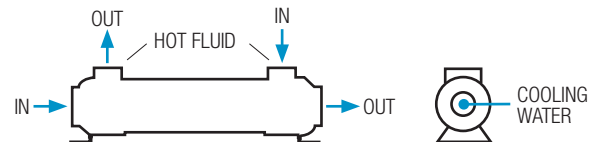

Two and Four Pass

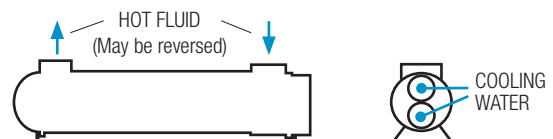

Specific applications may have different piping arrangements. Contact factory for assistance.

Performance Curves

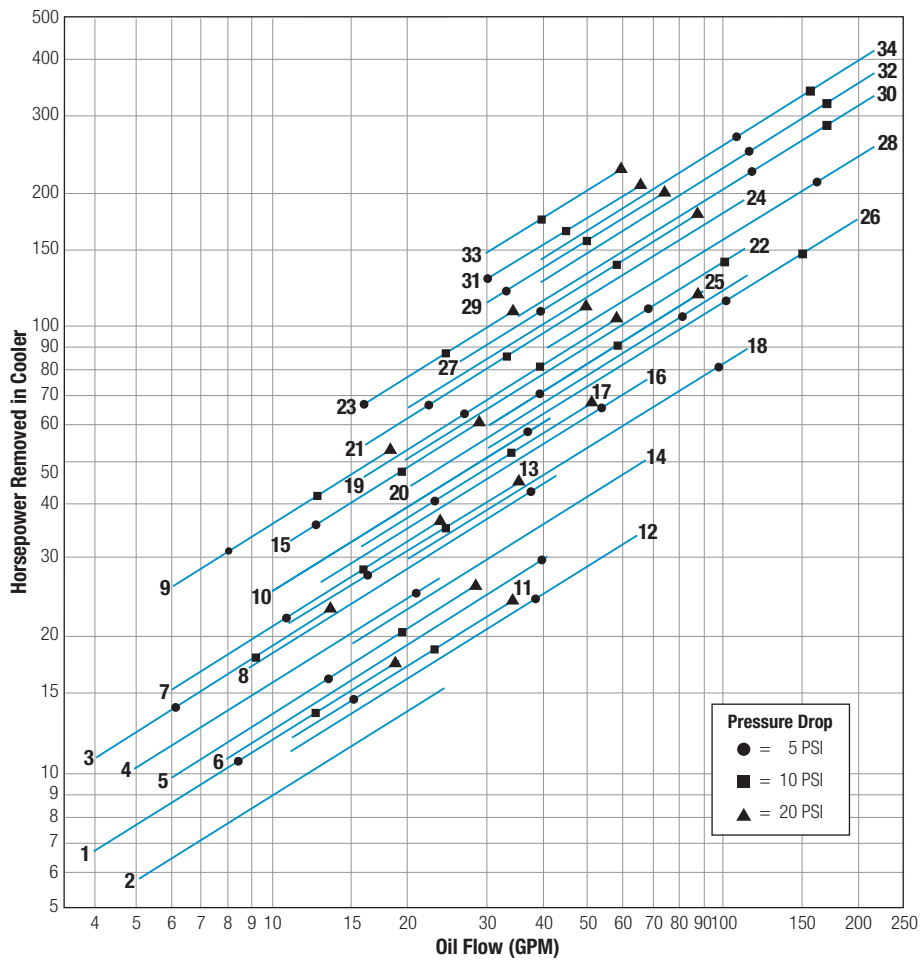

Curve Number	Model	Shipping Weight (LBS)
1	HC-614-1.3-4-F	17
2	HC-614-3-4-F	17
3	HC-624-1.3-4-F	24
4	HC-624-3-4-F	24
5	HC-814-1.7-4-F	32
6	HC-814-4-4-F	32
7	HC-824-1.7-4-F	41
8	HC-824-4-4-F	41
9	HC-836-1.7-4-F	53
10	HC-836-4-4-F	53
11	HC-1014-2-6-F	43
12	HC-1014-5-6-F	43
13	HC-1024-2-6-F	57
14	HC-1024-5-6-F	57
15	HC-1036-2-6-F	72
16	HC-1036-5-6-F	72
17	HC-1224-2.5-6-F	85
18	HC-1224-6-6-F	85
19	HC-1236-2.5-6-F	110
20	HC-1236-6-6-F	110
21	HC-1248-2.5-6-F	135
22	HC-1248-6-6-F	135
23	HC-1260-2.5-6-F	160
24	HC-1260-6-6-F	160
25	HC-1724-3.5-6-F	140
26	HC-1724-8.4-6-F	140
27	HC-1736-3.5-6-F	180
28	HC-1736-8.4-6-F	180
29	HC-1748-3.5-6-F	220
30	HC-1748-8.4-6-F	220
31	HC-1760-3.5-6-F	260
32	HC-1760-8.4-6-F	260
33	HC-1772-3.5-6-F	300
34	HC-1772-8.4-6-F	300

Shipping weights are approximate.

Dimensions

Four Pass

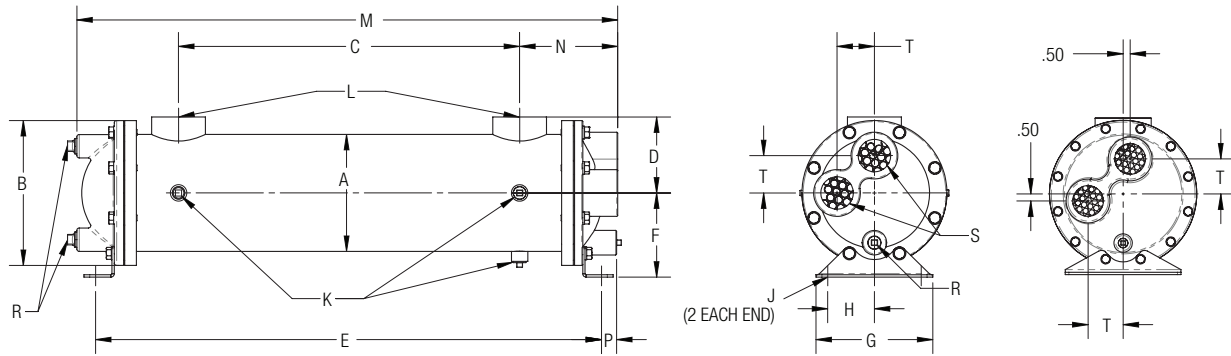

All models except
HC-1700 Series

HC-1700 Series

Model	A	B	C	D	E	F	G	H	J	K NPT	L		M	N	P	R NPT	S NPT	T
											NPT/ BSPP	SAE						
614	3.27	4.50	10.00	2.31	16.37	2.75	4.50	1.63	0.44	¼	1	-16 - 1 ½/16-12	17.19	3.62	0.44	¾ (2)	¾	1.00
624	3.27	4.50	20.00	2.31	26.37	2.75	4.50	1.63	0.44	¼	1	-16 - 1 ½/16-12	27.19	3.62	0.44	¾ (2)	¾	1.00
814	4.25	6.00	9.00	3.13	16.75	3.50	4.25	1.75	.44 x .63	¼	1 ½	-24 - 1 ½/8-12	17.87	4.44	0.59	¾ (2)	¾	1.25
824	4.25	6.00	19.00	3.13	26.75	3.50	4.25	1.75	.44 x .63	¼	1 ½	-24 - 1 ½/8-12	27.87	4.44	0.59	¾ (2)	¾	1.25
836	4.25	6.00	31.00	3.13	38.75	3.50	4.25	1.75	.44 x .63	¼	1 ½	-24 - 1 ½/8-12	39.87	4.44	0.59	¾ (2)	¾	1.25
1014	5.24	6.75	9.00	3.43	17.35	4.00	5.25	2.00	.50 x .75	¼	1 ½	-24 - 1 ½/8-12	18.83	4.83	0.69	¾ (2)	1	1.69
1024	5.24	6.75	19.00	3.43	27.35	4.00	5.25	2.00	.50 x .75	¼	1 ½	-24 - 1 ½/8-12	28.83	4.83	0.69	¾ (2)	1	1.69
1036	5.24	6.75	31.00	3.43	39.35	4.00	5.25	2.00	.50 x .75	¼	1 ½	-24 - 1 ½/8-12	40.83	4.83	0.69	¾ (2)	1	1.69
1224	6.26	7.75	18.25	4.06	27.07	4.50	6.25	2.50	.50 x .75	¾	2	-32 - 2 ½/2-12	28.94	5.25	0.87	¾ (1 - I/O) ½ (2 - RET)	1 ½	2.00
1236	6.26	7.75	30.25	4.06	39.07	4.50	6.25	2.50	.50 x .75	¾	2	-32 - 2 ½/2-12	40.94	5.25	0.87	¾ (1 - I/O) ½ (2 - RET)	1 ½	2.00
1248	6.26	7.75	42.25	4.06	51.07	4.50	6.25	2.50	.50 x .75	¾	2	-32 - 2 ½/2-12	52.94	5.25	0.87	¾ (1 - I/O) ½ (2 - RET)	1 ½	2.00
1260	6.26	7.75	54.25	4.06	63.07	4.50	6.25	2.50	.50 x .75	¾	2	-32 - 2 ½/2-12	64.94	5.25	0.87	¾ (1 - I/O) ½ (2 - RET)	1 ½	2.00
1724	8.62	10.50	17.00	5.43	27.31	5.75	8.25	3.50	.63 x .88	¾	3	-32 - 2 ½/2-12	30.47	7.20	2.08	¾ (1 - I/O) ½ (2 - RET)	2	2.50
1736	8.62	10.50	29.00	5.43	39.31	5.75	8.25	3.50	.63 x .88	¾	3	-32 - 2 ½/2-12	42.47	7.20	2.08	¾ (1 - I/O) ½ (2 - RET)	2	2.50
1748	8.62	10.50	41.00	5.43	51.31	5.75	8.25	3.50	.63 x .88	¾	3	-32 - 2 ½/2-12	54.47	7.20	2.08	¾ (1 - I/O) ½ (2 - RET)	2	2.50
1760	8.62	10.50	53.00	5.43	63.31	5.75	8.25	3.50	.63 x .88	¾	3	-32 - 2 ½/2-12	66.47	7.20	2.08	¾ (1 - I/O) ½ (2 - RET)	2	2.50
1772	8.62	10.50	65.00	5.43	75.31	5.75	8.25	3.50	.63 x .88	¾	3	-32 - 2 ½/2-12	78.47	7.20	2.08	¾ (1 - I/O) ½ (2 - RET)	2	2.50

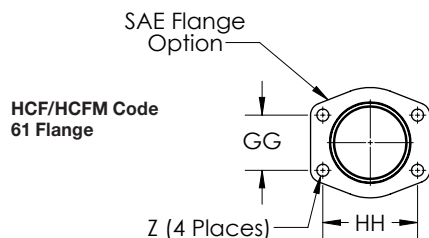

HCF/HC FM Code
61 Flange

Flange Size	GG	HH	Z - HCF	Z - HC FM
1	1.03	2.06	3/8 - 16 UNC	M-10
1.50	1.41	2.75	1/2 - 13 UNC	M-12
2	1.69	3.06	1/2 - 13 UNC	M-12
3	2.44	4.19	5/8 - 11 UNC	M-16