

Fluid Cooling Mobile AOHM / AOVHM Series

Performance Notes

- AO/AOVH Series with hydraulic motor
- Adjustable louvers (manual)
- High heat removal
- Heavy duty construction
- Wide flow range
- Heat removal up to 210,000 BTU/HR
- Long life hydraulic motor
- NPT connections



Options

Internal pressure bypass
SAE or BSPP connections
Corrosion resistant coating

Ratings

Maximum Operating Pressure
300 PSI

Test Pressure
300 PSI

Maximum Operating Temperature
400°F

Materials

Tubes Copper

Fins Aluminum

Turbulators Steel

Manifolds Steel

Connections Steel

Cabinet Steel with powder coat finish

Fan Blade Aluminum with steel hub

Fan Guard Zinc plated steel

Fan Adapter Steel

How to Order

Model Series	Model Size Selected	Number of Passes*	Connection Type	Bypass*	Foot Mounting Brackets	
AOHM AOHMR AOVHM AOVHMR		Blank - No Bypass 1 - One Pass 2 - Two Pass	Blank - NPT S - SAE	Blank - No Bypass 30 - 30 PSI 60 - 60 PSI	Blank - No Brackets FB - Foot Brackets	
					ADD FOR AOHM & AOHMR MODELS ONLY	

AOHMR - Internal pressure bypass included

AOVHMR - Internal pressure bypass included (available in Two Pass only)

This is a partial flow pressure bypass only. It is not designed to be a full flow system bypass.

Other connection types available. Please consult factory for assistance.

***ADD FOR AOHMR & AOVHMR MODELS ONLY**

Dimensions

Fan Rotating Clockwise/Facing Motor Shaft

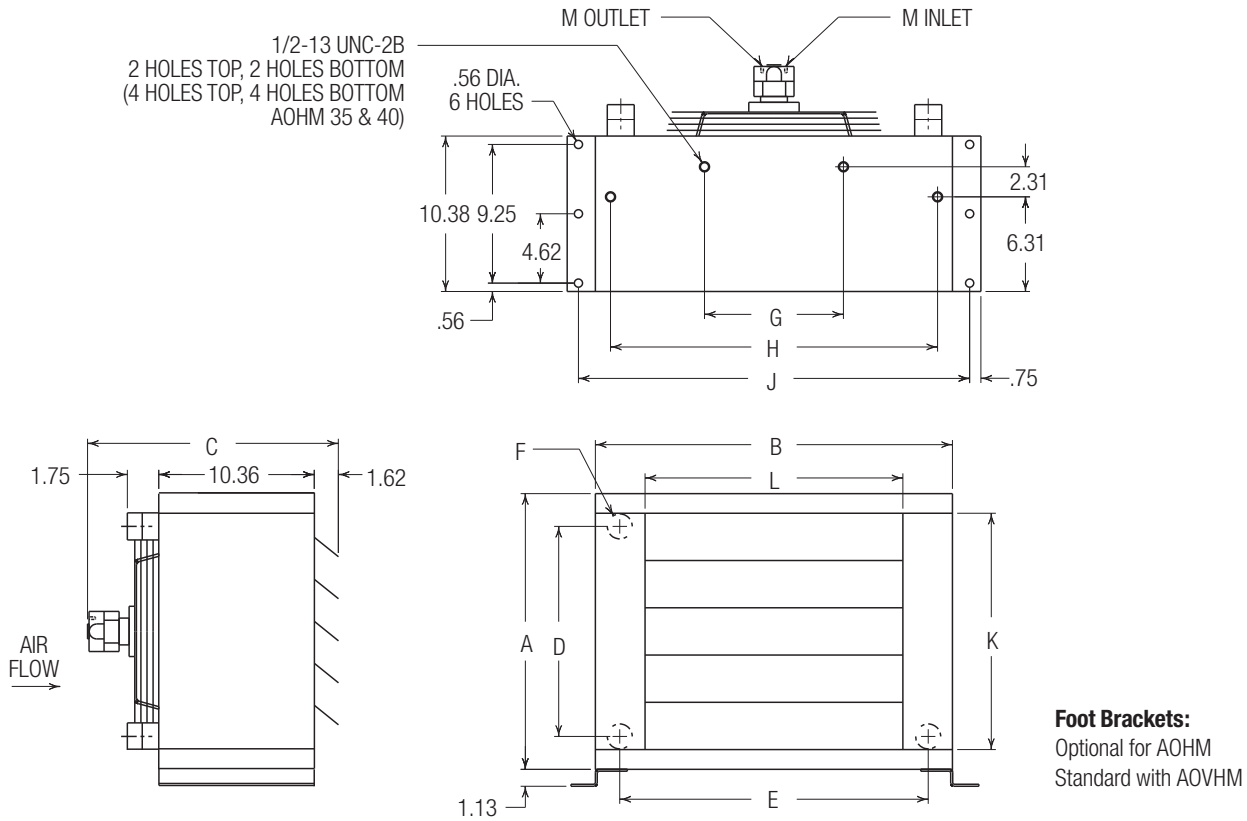

See dimensional chart for external NPT or optional internal SAE connection size.

Model	A	B	C	D	E	F		G	H	J	K	L	M (SAE)	Net Weight. (LBS)
						NPT	SAE							
AOHM-5	11.81	14.81	16.70	7.69	11.69	1"	#16	—	12.94	16.81	9.19	8.31	#8	35
AOVHM-5	11.81	14.81	16.70	7.69	11.69	1½"	#24	—	12.94	16.81	9.19	8.31	#8	59
AOHM-10	13.12	19.00	16.70	8.88	15.88	1"	#16	—	17.12	21.00	10.50	12.50	#8	50
AOVHM-10	13.12	19.00	16.70	8.88	15.88	1½"	#24	—	17.12	21.00	10.50	12.50	#8	76
AOHM-15	15.75	20.38	17.09	11.50	17.25	1"	#16	—	18.50	22.38	13.12	13.88	#8	60
AOVHM-15	15.75	20.38	17.09	11.50	17.25	1½"	#24	—	18.50	22.38	13.12	13.88	#8	89
AOHM-20	18.38	23.81	17.09	14.00	20.56	1¼"	#20	—	21.81	25.81	15.75	17.19	#8	75
AOVHM-20	18.38	23.81	17.09	14.00	20.56	2"	#32	—	21.81	25.81	15.75	17.19	#8	108
AOHM-25	23.62	26.68	17.09	19.25	23.56	1¼"	#20	—	24.81	28.68	21.00	20.19	#8	110
AOVHM-25	23.62	26.68	17.25	19.25	23.56	2"	#32	—	24.81	28.68	21.00	20.19	#8	143
AOHM-30	27.56	31.62	16.70	23.19	28.50	1¼"	#20	11.00	29.75	33.62	24.94	25.12	#8	120
AOVHM-30	27.56	31.62	16.95	23.19	28.50	2"	#32	11.00	29.75	33.62	24.94	25.12	#8	178
AOHM-35	30.19	33.81	16.70	25.81	30.69	1¼"	#20	11.00	31.94	35.81	27.56	27.31	#8	135
AOVHM-35	30.19	33.81	17.22	25.81	30.69	2"	#32	11.00	31.94	35.81	27.56	27.31	#10	220
AOHM-40	36.75	41.62	16.70	32.38	38.50	1¼"	#20	13.25	39.75	43.62	34.12	35.12	#8	160
AOVHM-40	36.75	41.62	17.22	32.38	38.50	2"	#32	13.25	39.75	43.62	34.12	35.12	#10	286

NOTE: We reserve the right to make reasonable design changes without notice. All dimensions are in inches.

Performance Curves

AOHM Series

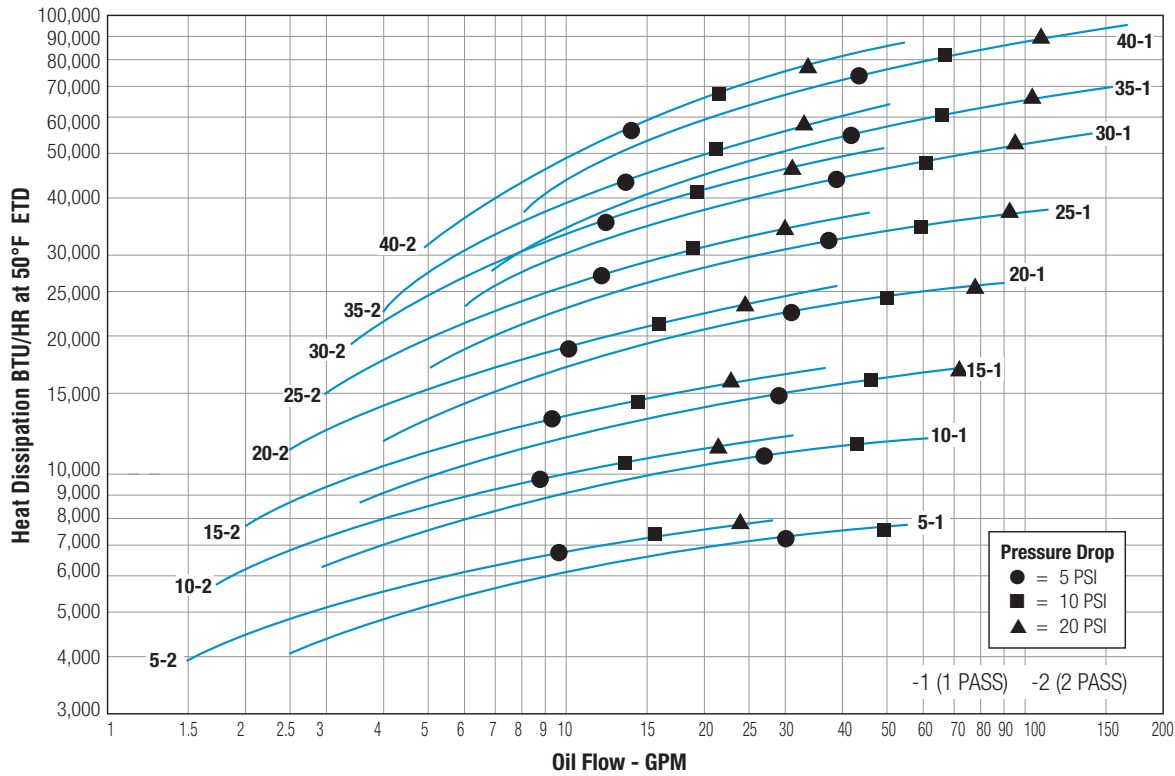

AOVHM Series

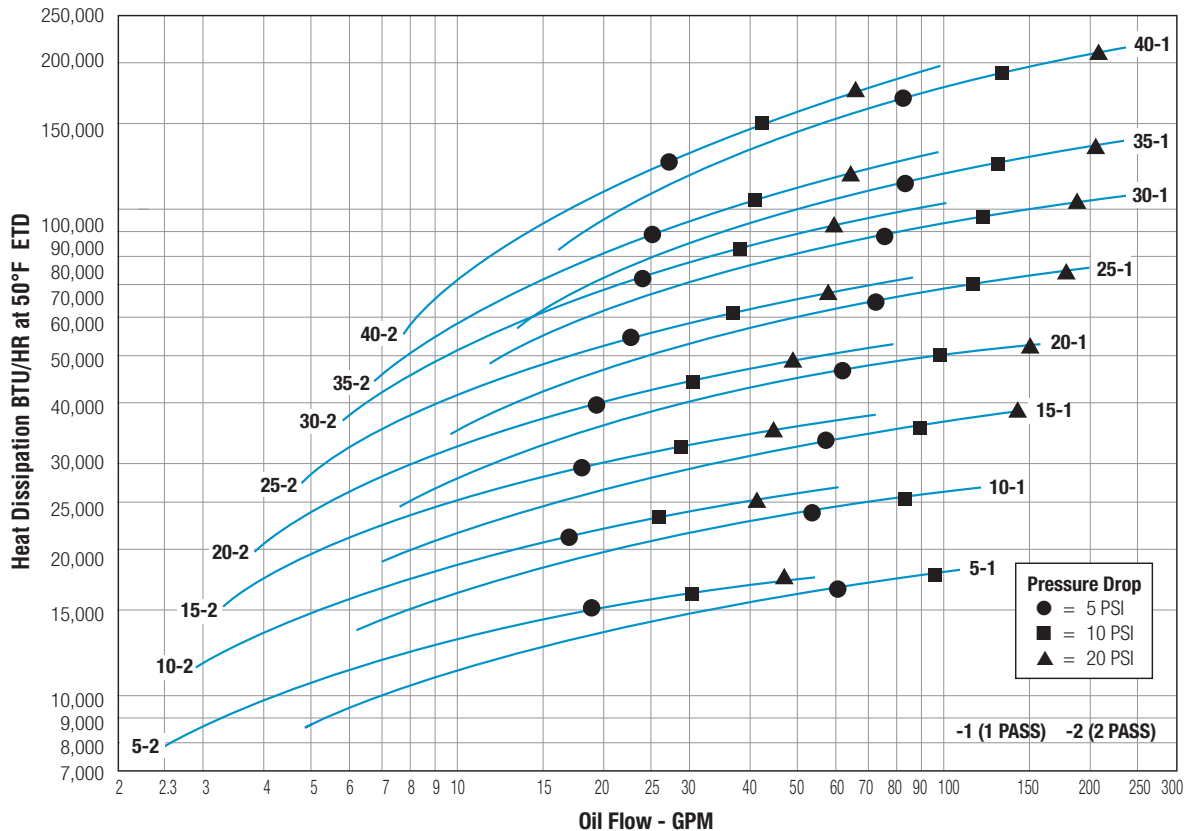

Dimensions

Performance Curves are based on 50 SSU oil entering the cooler 50°F higher than the ambient air temperature used for cooling. This is referred to as a 50°F ETD

STEP 1 Determine the Heat Load. Heat load may be expressed as either horsepower or BTU/HR To convert horsepower to BTU/HR:
 $BTU/HR = \text{Horsepower} \times 2545$

STEP 2 Determine Entering Temperature Difference. The entering oil temperature is generally the maximum desired oil temperature.
 Entering oil temperature – Ambient air temperature = ETD

STEP 3 Determine the Corrected Heat Dissipation to use the curves.
 Corrected Heat Dissipation =
 $BTU/HR \text{ heat load} \times \frac{50^\circ F}{ETD} \times \text{viscosity correction A.}$

STEP 4 Enter curves at oil flow through cooler and curve heat dissipation. Any curve above the intersecting point will work.

NOTE: Performance curves shown are for 1 and 2 pass configuration.

EXAMPLE: 35 - 2 is AOHM or AOVHM - 35 in 2 pass

STEP 5 Determine Oil Pressure Drop from Curves:
 ● = 5 PSI ■ = 10 PSI ▲ = 20 PSI Multiply pressure drop from curve by correction factor B found in oil viscosity correction curve.

Oil Viscosity Correction Multipliers

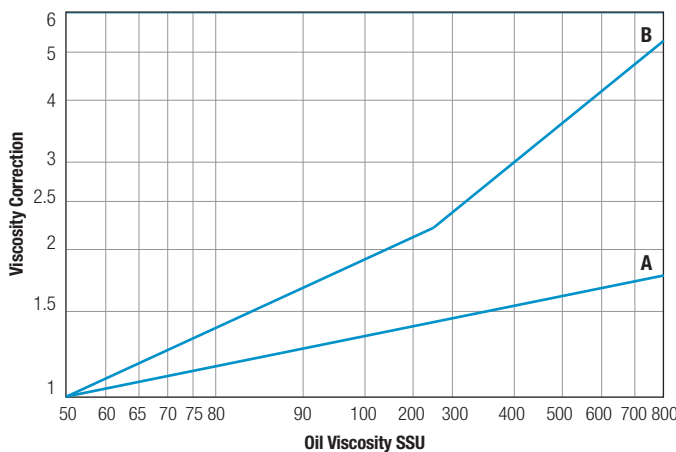

Desired Reservoir Temperature

Oil Temperature: Oil coolers can be selected using entering or leaving oil temperatures.

Off-Line Recirculation Cooling Loop: Desired reservoir temperature is the oil temperature entering the cooler.

Return Line Cooling: Desired reservoir temperature is the oil temperature leaving the cooler. In this case, the oil temperature change must be determined so that the actual oil entering temperature can be found. Calculate the oil temperature change (oil ΔT) with this formula:
 $\text{Oil } \Delta T = (BTU's/HR) / (GPM \text{ Oil Flow} \times 210).$

To calculate the oil entering temperature to the cooler, use this formula:
 $\text{Oil Entering Temp.} = \text{Oil Leaving Temp.} + \text{Oil } \Delta T.$

Oil Pressure Drop: Most systems can tolerate a pressure drop through the heat exchanger of 20 to 30 PSI. Excessive pressure drop should be avoided. Care should be taken to limit pressure drop to 5 PSI or less for case drain applications where high back pressure may damage the pump shaft seals.

Oil Temperature

Typical operating temperature ranges are:

Hydraulic Motor Oil	120°F - 180°F
Hydrostatic Drive Oil	160°F - 180°F
Engine Lube Oil	180°F - 200°F
Automatic Transmission Fluid	200°F - 300°F

Hydraulic Motor

Model Size	Maximum Fan Speed (RPM)		Oil Flow Required (GPM)		Minimum Operating Pressure (PSI)		Sound dB(A)*		Motor (IN ³ /REV.) Displacement		CFM	
	AOHM	AOVHM	AOHM	AOVHM	AOHM	AOVHM	AOHM	AOVHM	AOHM	AOVHM	AOHM	AOVHM
5	1725	3450	1.6	3.3	300	300	68	85	.22	.22	465	780
10	1725	3450	1.6	3.3	300	300	68	85	.22	.22	669	1110
15	1725	3450	1.6	3.3	300	300	69	91	.22	.22	956	1590
20	1725	3450	1.6	3.3	300	300	70	91	.22	.22	1460	2168
25	1140	1725	1.1	3.4	400	500	72	81	.22	.45	2160	3000
30	1140	1725	1.1	3.4	400	500	75	84	.22	.45	2990	4095
35	1140	1725	1.1	5.2	900	1000	76	89	.22	.70	4370	5921
40	1140	1725	1.1	5.2	900	1000	78	91	.22	.70	5450	9609

Notes: Maximum pressure is 2000 PSI. Stated minimum operating pressure is at inlet port of motor. 1000 PSI allowable back pressure.

*Catalog db(A) sound levels are at seven (7) feet. db(A) sound levels increase by six (6) db(A) for halving this distance and decrease by (6) db(A) for doubling this distance.

Internal Pressure Bypass

AOHMR Series

One Pass (Medium to High Oil Flows)

Model Number	Flow Range GPM (USA)
AOHMR - 5-1	2 - 80
AOHMR - 10-1	3 - 80
AOHMR - 15-1	4 - 80
AOHMR - 20-1	5 - 80
AOHMR - 25-1	6 - 100
AOHMR - 30-1	7 - 100
AOHMR - 35-1	8 - 112
AOHMR - 40-1	9 - 118

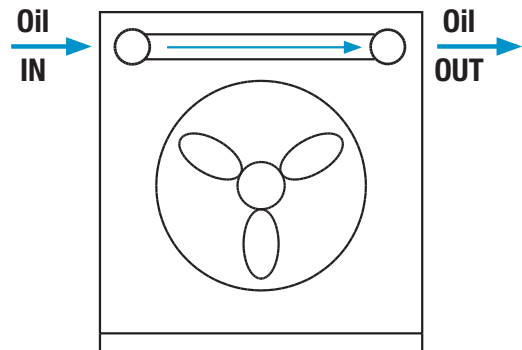

Two Pass (Low to Medium Oil Flows)

Model Number	Flow Range GPM (USA)
AOHMR - 5-2	2 - 25
AOHMR - 10-2	2 - 30
AOHMR - 15-2	2 - 40
AOHMR - 20-2	2 - 30
AOHMR - 25-2	2 - 40
AOHMR - 30-2	2 - 40
AOHMR - 35-2	3 - 40
AOHMR - 40-2	4 - 40

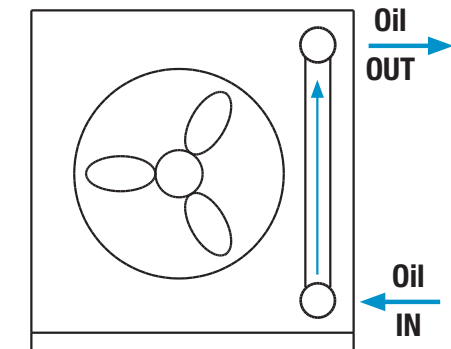

AOVHMR Series

Two Pass (Low to Medium Oil Flows)

Model Number	Flow Range GPM (USA)
AOVHMR - 5-2	4 - 50
AOVHMR - 10-2	4 - 60
AOVHMR - 15-2	4 - 60
AOVHMR - 20-2	4 - 80
AOVHMR - 25-2	4 - 80
AOVHMR - 30-2	4 - 80
AOVHMR - 35-2	6 - 80
AOVHMR - 40-2	8 - 80

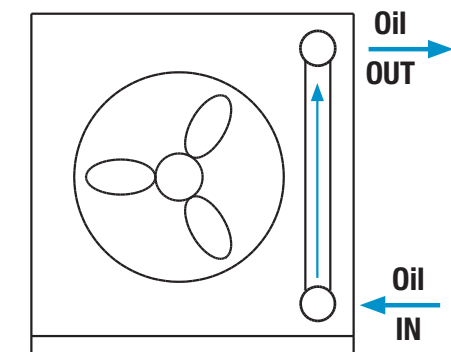

Bypass valve is available for 2 pass AOVHMR models only.

Piping Diagram Without Bypass

