

FLUID COOLING | Industrial AOF Series

AIR COOLED AOF

FEATURES

- AOF with Removable Filter
- Adjustable Louvers
- Medium Flow Rates
- Moderate Heat Removal
- One or Two Pass Option
- Fluid Power Systems
- Gear Drives
- Injection Molding Machines
- Machine Tools
- Torque Converters
- Hydraulic Presses

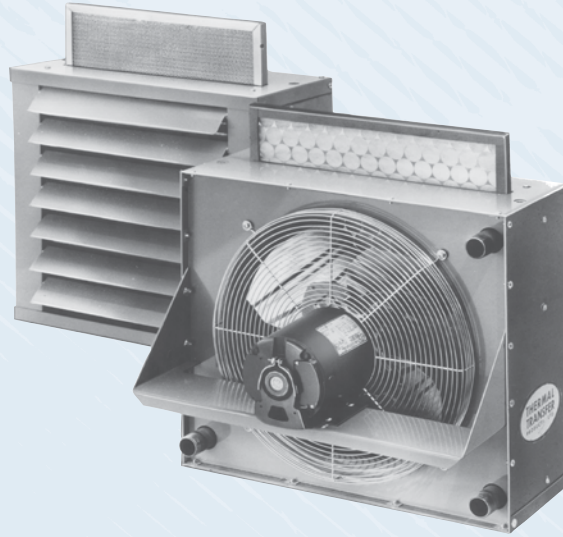

OPTIONS

- SAE & Metric Connections
- Built-in Bypass Relief
- Foot Mounting Brackets
- Corrosion Resistant/Marine Duty Coating

Ratings

- Operating Pressure** - 300 psi
- Test Pressure** - 300 psi
- Operating Temperature** - 400° F

Replacement Air Filters

MODEL	Fiberglass Disposable Type Part Number	Aluminum Washable Type Part Number
AOF - 5	65528	65559
AOF - 10	65530	65560
AOF - 15	65507	65561
AOF - 20	65532	65562
AOF - 25	65519	65563
AOF - 30	65535	65564
AOF - 35	65537	65565
AOF - 40	65543	65566

Materials

- Tubes** Copper
- Fins** Aluminum
- Turbulators** Steel
- Fan Blade** Aluminum with steel hub
- Fan Guard** Zinc plated steel
- Cabinet** Steel with baked enamel finish
- Manifolds and Connection Pipes** Steel

Weights

MODEL	Net Weight (LBS)
AOF-5	60
AOF-10	70
AOF-15	80
AOF-20	95
AOF-25	125
AOF-30	140
AOF-35	165
AOF-40	230

How to Order

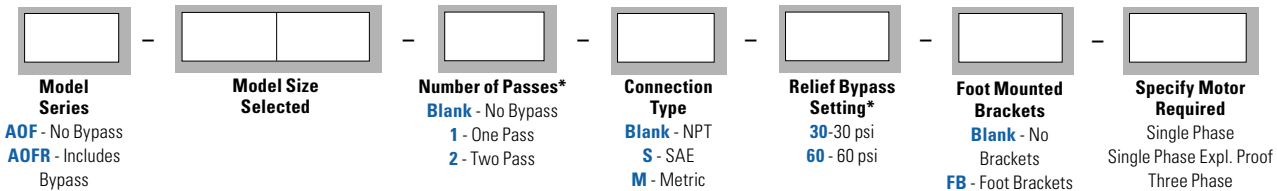

*ADD FOR AOFR MODELS ONLY: Relief Bypass Setting & Number of Passes

Dimensions

Model	A	B	C	D	E	F	G	H	J	K	L	M NPT	M SAE	N	P	Q	R	S	T
AOF-5	7.40	14.81	5.90	11.81	17.50	9.19	8.31	6.47	12.94	3.78	7.69	1"	#16 SAE 1-5/16-12UN-2B Thread	5.84	11.69	10.06	1.09	3.92	—
AOF-10	9.50	19.00	6.56	13.12	17.00	10.50	12.50	8.56	17.12	4.44	8.88	1"		7.94	15.88	14.38	1.09	3.92	—
AOF-15	10.19	20.38	7.87	15.75	17.62	13.12	13.88	9.25	18.50	5.75	11.50	1"		8.62	17.25	15.62	1.09	3.92	—
AOF-20	11.91	23.81	9.19	18.38	19.62	15.75	17.91	10.90	21.81	7.00	14.00	1-1/4"	#20 SAE 1-5/8-12UN-2B Thread	10.28	20.56	18.62	1.09	3.92	—
AOF-25	13.34	26.68	11.81	23.62	20.68	21.00	20.19	12.40	24.81	9.62	19.25	1-1/4"		11.78	23.56	21.62	1.09	3.92	—
AOF-30	15.81	31.62	13.78	27.56	20.12	24.94	25.12	14.87	29.75	11.59	23.19	1-1/4"		14.25	28.50	26.62	1.09	3.92	11.00
AOF-35	16.90	33.81	15.09	30.19	21.25	27.56	27.31	15.97	31.94	12.90	25.81	1-1/4"		15.34	30.69	28.88	1.09	3.94	11.00
AOF-40	20.81	41.62	18.37	36.75	20.31	34.12	35.12	19.87	39.75	16.19	32.38	1-1/4"	19.25	38.50	37.00	1.18	3.87	13.25	

Installation Piping Diagram

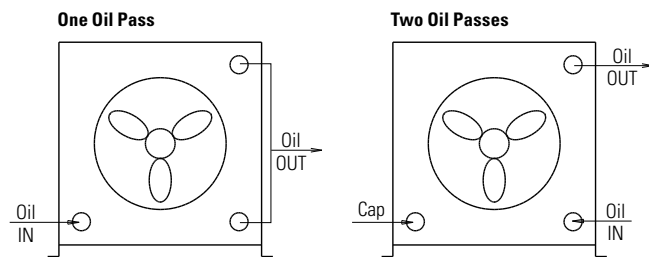

*See dimension chart for NPT or optional internal SAE connection size.
NOTE: All dimensions in inches.

Fan Rotation Clockwise/Facing Motor Shaft

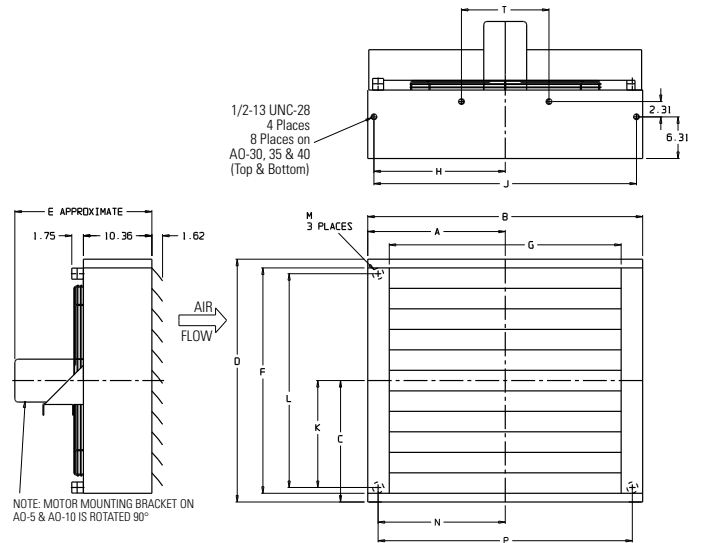

Lubrication Notes

Caution: Do not over oil or over grease. **Ball bearings** – No grease needed at start up. Grease as follows:

5,000 Hours/Year	5 Year Grease Interval
Continuous Normal Applications	2 Years
Seasonal Service Motor is idle for 6 months or more	1 Year
Continuous High ambients, dirty or moist locations, high vibration	6 Months

Performance Curves

One Pass Oil

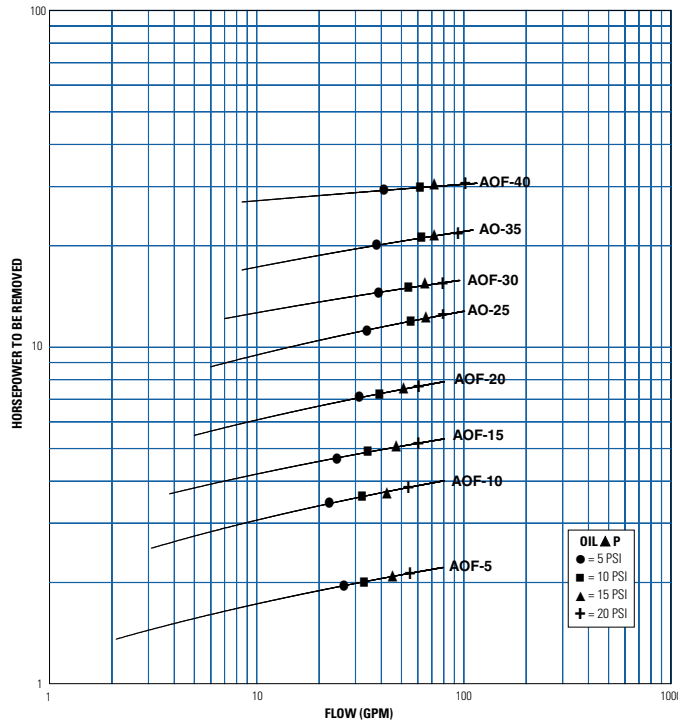

Two Pass Oil

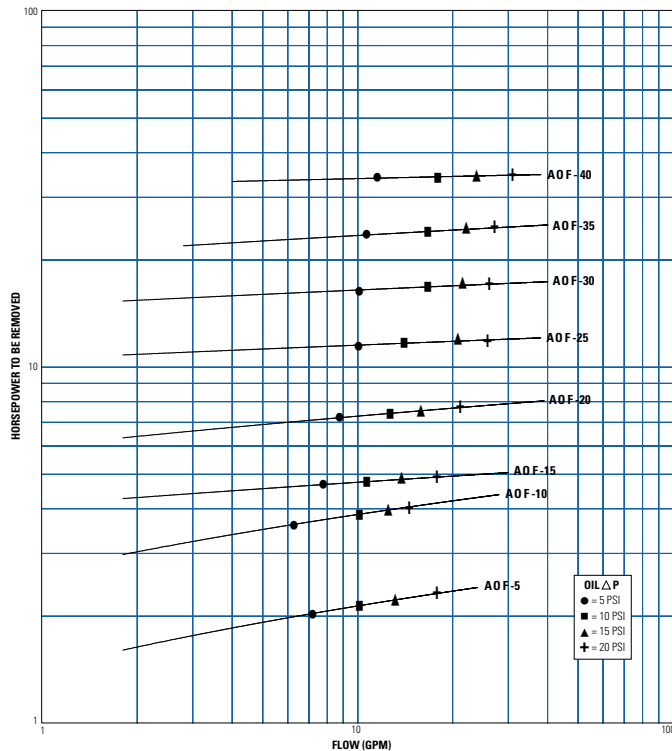

Selection Procedure

Performance Curves are based on 50SSU oil leaving the cooler 40°F higher than the ambient air temperature used for cooling. This is also referred to as a 40°F approach temperature.

STEP 1 Determine the Heat Load. This will vary with different systems, but typically coolers are sized to remove 25 to 50% of the input nameplate horsepower.

(Example: 100 HP Power Unit x .33 = 33 HP Heat load.)

If BTU/Hr. is known: $HP = \frac{BTU/Hr}{2545}$

STEP 2 Determine Approach Temperature. Desired oil leaving cooler °F – Ambient air temp. °F = Actual Approach

STEP 3 Determine Curve Horsepower Heat Load. Enter the information from above:

Horsepower heat load x $\frac{40 \times Cv}{Actual\ Approach}$ = Curve Horsepower

STEP 4 Enter curves at oil flow through cooler and curve horsepower. Any curve above the intersecting point will work.

STEP 5 Determine Oil Pressure Drop from Curves:

● = 5 PSI; ■ = 10 PSI; ▲ = 15 PSI; + = 20 PSI. Multiply pressure drop from curve by correction factor found in oil Δ P correction curve.

Desired Reservoir Temperature

Return Line Cooling: Desired temperature is the oil temperature leaving the cooler. This will be the same temperature that will be found in the reservoir.

Off-Line Recirculation Cooling Loop: Desired temperature is the oil temperature entering the cooler. In this case, the oil temperature change must be determined so that the actual oil leaving temperature can be found. Calculate the oil temperature change (oil Δ T) with this formula:
 Oil Δ T = (BTU's/Hr.) / (GPM Oil Flow x 210).

To calculate the oil leaving temperature from the cooler, use this formula:
 Oil Leaving Temp. = Oil Entering Temp – Oil Δ T.

This formula may also be used in any application where the only temperature available is the entering oil temperature.

Oil Pressure Drop: Most systems can tolerate a pressure drop through the heat exchanger of 20 to 30 PSI. Excessive pressure drop should be avoided. Care should be taken to limit pressure drop to 5 PSI or less for case drain applications where high back pressure may damage the pump shaft seals.

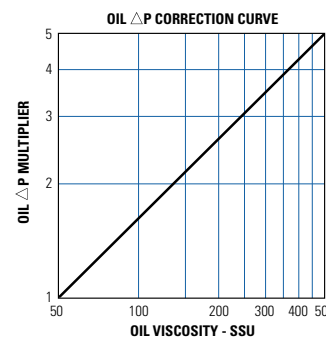

Oil Temperature

Typical operating temperature ranges are:

Hydraulic Motor Oil	110° - 130°F
Hydrostatic Drive Oil	130° - 180°F
Bearing Lube Oil	120° - 160°F
Lube Oil Circuits	110° - 130°F

C_v Viscosity Correction

Average Oil Temp °F	OIL					
	SAE 5 110 SSU at 100°F 40 SSU at 210°F	SAE 10 150 SSU at 100°F 43 SSU at 210°F	SAE 20 275 SSU at 100°F 50 SSU at 210°F	SAE 30 500 SSU at 100°F 65 SSU at 210°F	SAE 40 750 SSU at 100°F 75 SSU at 210°F	50-50 Ethylene Glycol & Water
100	1.14	1.22	1.35	1.58	1.77	1.11
150	1.01	1.05	1.11	1.21	1.31	1.02
200	.99	1.00	1.01	1.08	1.10	.96
250	.95	.98	.99	1.00	1.00	.95

Specifications

Electric motor & Fan data*

Model	CFM	Sound dB(A)** at 7 ft.	Horse Power	Volts	Phase	Full Load Amps	Hz	Nema Frame	RPM	Type	Circuit	Thermal Overload	Bearing B-Ball S-Sleeve
AOF-5	465	68	1/6	115/208-230	1	4/2.1-2	60	48	1725	TEFC	C D	No	B
	494	70	1/4	208-230/460	3	1.4-1.3/.65							
AOF-10	669	68	1/6	115/208-230	1	4/2.1-2	60	48	1725	TEFC	C D	No	B
	710	70	1/4	208-230/460	3	1.4-1.3/.65							
AOF-15	956	69	1/4	115/208-230	1	5.8/3-2.9	60	48	1725	TEFC	C D	No	B
	1015	71		208-230/460	3	1.4-1.3/.65							
AOF-20	1460	70	1/2	115/208-230	1	7.8/4.1-3.9	60	48	1725	TEFC	C D	No	B
	1555	72		208-230/460	3	2.1-2/.1.							
AOF-25	2160	72	1/2	115/208-230	1	8/4.2-4	60	56	1140	TEFC	C D	No	B
	2240	73		208-230/460	3	2.5-2.4/1.2							
AOF-30	2990	75	1/2	115/208-230	1	8/4.2-4	60	56	1140	TEFC	C D	No	B
	3100	76		208-230/460	3	2.5-2.4/1.2							
AOF-35	NOT AVAILABLE				1	4-3.8/1.9	60	56	1140	TEFC	D	No	B
	4370	77	1.0	208-230/460	3								
AOF-40	NOT AVAILABLE				1	4-3.8/1.9	60	56	1140	TEFC	D	No	B
	5450	79	1.0	208-230/460	3								

*Published electrical ratings are approximate, and may vary because of motor brand. Actual ratings are on motor nameplate.

**Catalog dB(A) sound levels are at seven (7) feet. dB(A) sound levels increase by six (6) dB(A) for halving this distance and decrease by six (6) dB(A) for doubling this distance.

Explosion Proof Motors (Class I GP.D & Class II GP.F, G)*

Model	CFM	Sound dB(A)** at 7 ft.	Horse Power	Volts	Phase	Full Load Amps	Hz	Nema Frame	RPM	Type	Circuit	Thermal Overload	Bearing B-Ball S-Sleeve
AOF-5	494	68	1/4	115/230	1	5.8/2.9	60	48	1725	FC	C D	Yes	B
		70		208-230/460	3	1.4-1.3/.65							
AOF-10	710	68	1/4	115/230	1	5.8/2.9	60	48	1725	FC	C D	Yes	B
		70		208-230/460	3	1.4-1.3/.76							
AOF-15	1015	69	1/4	115/230	1	5.8/2.9	60	48	1725	FC	C D	Yes	B
		71		208-230/460	3	1.4-1.3/.65							
AOF-20	1555	70	1/2	115/230	1	7.8/3.9	60	48	1725	FC	C D	Yes	B
		72		208-230/460	3	2.1-2/.1.							
AOF-25	2240	72	1/2	115/230	1	8/4.	60	56	1140	FC	C D	Yes	B
		73		230/460	3	2.5-2.4/1.2							
AOF-30	3100	75	1/2	115/230	1	8/4.	60	56	1140	FC	C D	Yes	B
		76		230/460	3	2.5-2.4/1.2							
AOF-35 ▲	NOT AVAILABLE				1	3.8/1.9	60	56	1140	FC	D	No	B
	4370	77	1.0	230/460	3								
AOF-40 ▲	NOT AVAILABLE				1	3.8/1.9	60	56	1140	FC	D	No	B
	5450	79	1.0	230/460	3								

▲ = AOF 35 & 40, CL. 1, GP. D only **TEFC** = Totally enclosed, fan cooled **FC** = Fan cooled **C** = Capacitor start - Induction run **D** = Squirrel cage

*Published electrical ratings are approximate, and may vary because of motor brand. Actual ratings are on motor nameplate.

575 Volt Specifications

Model	CFM	Sound dB(A)** at 7 ft.	Horse Power	Volts	Phase	Full Load Amps	Hz	Nema Frame	RPM	Type	Circuit*	Thermal Overload	Bearing B-Ball S-Sleeve
AOF-5	494	70	1/4	575	3	.52	60	48	1725	TEFC	D	No	B
AOF-10	710	70	1/4	575	3	.52	60	48	1725	TEFC	D	No	B
AOF-15	1015	71	1/4	575	3	.52	60	48	1725	TEFC	D	No	B
AOF-20	1555	72	1/2	575	3	.80	60	48	1725	TEFC	D	No	B
AOF-25	2240	73	1/2	575	3	.88	60	56	1140	TEFC	D	No	B
AOF-30	3100	76	1/2	575	3	.88	60	56	1140	TEFC	D	No	B
AOF-35	4370	77	1.0	575	3	1.6	60	56	1140	TEFC	D	No	B

Catalog dB (A) sound levels at seven (7) feet. dB (A) sound levels increase by six (6) dB (A) for halving this distance, and decrease by six (6) dB (A) for doubling this distance.